



ASSEMBLY

Dentalife Ceccato

Gamma di compressori a pistoncini dentali/medicali oilfree silenziosi



La gamma di compressori DENTALIFE è stata studiata e sviluppata per quelle applicazioni che richiedono un'aria priva di impurità e necessitano della massima silenziosità durante il funzionamento, come le applicazioni negli studi dentistici, laboratori medici, sale operatorie o altre applicazioni critiche.





ASSEMBLY

Mercati di riferimento

- Mercato dentale e medicale
- Utilizzi professionali
- Laboratori vari
- Food & beverage





ASSEMBLY

Dentalife Ceccato

La gamma di compressori DENTALIFE è stata studiata e sviluppata per offrire le migliori performance in:

- Affidabilità
- Silenziosità
- Prezzo
- Tecnologia e Design
- Facilità di utilizzo e di manutenzione

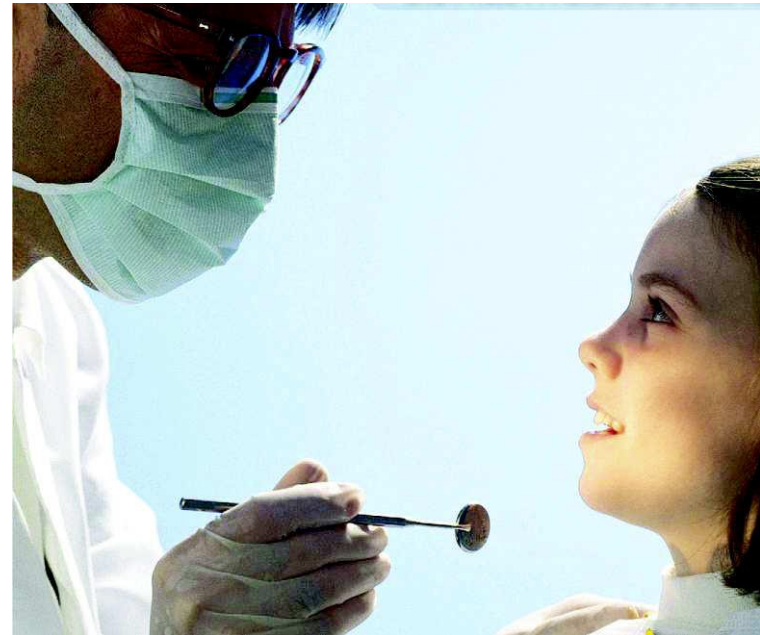



ASSEMBLY

Dentalife Ceccato

- 4 gruppi pompanti
- 6 gamme
- 34 modelli
- Aria per il funzionamento da 1 a 7 riuniti (poltrona del dentista)
- Da 0,75 a 3+3 hp
- Serbatoi da 24 a 100 litri

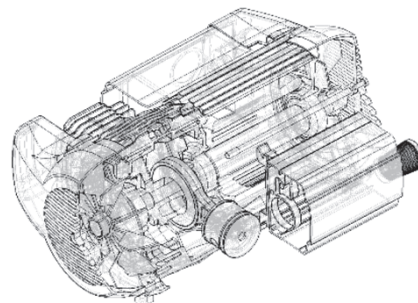



ASSEMBLY

Gamma DENTALIFE START

GRUPPI
POMPANTI
AD1 – AD2

■ DENTALIFE START

- Linea base con basso costo di installazione
- Serbatoi da 24 a 50 litri.
- Potenze 0,75 e 1,5 hp.



■ DENTALIFE START DRY

- Versione base con essiccatore a membrana, aftercooler e filtro da 0,01 micron.
- Serbatoi da 30 a 50 litri.
- Potenze 0,75 e 1,5 hp.





Gamma DENTALIFE

**GRUPPI
POMPANTI
BD1 – BD2 – BD3**

ASSEMBLY

■ DENTALIFE

- Gamma che garantisce performance affidabili, durevoli ed un utilizzo continuativo a livello professionale.
- Serbatoi da 30 a 100 litri.
- Potenze 1 - 2 - 3 hp. Versione tandem 2+2 e 3+3 hp



■ DENTALIFE DRY

- Versione con essiccatore a membrana, aftercooler e filtro da 0,01 micron con punto di rugiada medio costante a -30°C ad una pressione di 7 bar.
 - Serbatoi da 30 a 100 litri.
 - Potenze 1 - 2 - 3 hp.
- Versione tandem 2+2 e 3+3 hp





Gamma DENTALIFE SIL

**GRUPPI
POMPANTI
BD1 – BD2 – BD3**

ASSEMBLY

■ DENTALIFE SIL

- Gamma silenziata con un box insonorizzante che consente di ridurre ulteriormente il rumore fino ad un minimo di 55 decibel e proteggere il compressore dagli agenti atmosferici nel caso venga installato all'esterno.
- Serbatoi da 30 a 100 litri.
- Potenze 1 - 2 - 3 hp. Versione tandem 2+2 e 3+3 hp



■ DENTALIFE SIL DRY

- Versione silenziata con essiccatore a membrana, aftercooler e filtro da 0,01 micron.
- Serbatoi da 30 a 100 litri.
- Potenze 1 - 2 - 3 hp. Versione tandem 2+2 e 3+3 hp





ASSEMBLY

Gamma completa



Modello	Codice	N. riuniti	Aria aspirata l/min	FAD @ 5bar		Motore		Alimentazione V/Hz/fasi	Serbatoio Lt	Pressione BAR	Livello sonoro dB(A)	Dimensioni l x p x a mm	Peso Kg
				l/min	HP	kW							
DENTALIFE START													
24AD1M075	DC00000001	1	130	77	0,75	0,55	230/50/1	24	8	69	400x400x550	28	
30AD1M075	DC00000002	1	130	77	0,75	0,55	230/50/1	30	8	69	390x570x620	34	
24AD2M15	DC00000003	2	182	135	1,5	1,1	230/50/1	24	8	69	400x400x550	29	
30AD2M15	DC00000004	2	182	135	1,5	1,1	230/50/1	30	8	69	390x570x620	34	
50AD2M15	DC00000005	2	182	135	1,5	1,1	230/50/1	50	8	69	380x400x890	48	
SILBOX 24	DC00000006									-10	470x460x620	16	
DENTALIFE START DRY													
30AD1M075E	DC00000007	1	130	65	0,75	0,55	230/50/1	30	8	69	430x570x620	37	
30AD2M15E	DC00000008	2	182	120	1,5	1,1	230/50/1	30	8	69	430x570x620	38	
50AD2M15E	DC00000009	2	182	135	1,5	1,1	230/50/1	50	8	69	380x400x890	59	
DENTALIFE													
30BD1M1	DC00000010	1	120	85	1	0,75	230/50/1	30	8	69	390x570x720	33	
30BD2M2	DC00000011	2	240	170	2	1,5	230/50/1	30	8	69	390x570x660	42	
50BD2M2	DC00000012	3	300	170	2	1,5	230/50/1	50	8	69	520x520x900	49	
50BD3M3	DC00000013	4	360	250	3	2,2	230/50/1	50	8	69	520x520x900	52	
50BD3T3	DC00000014	4	360	250	3	2,2	400/50/3	50	8	69	520x520x900	52	
100BD2T22T	DC00000015	7	480	340	2+2	1,5+1,5	400/50/3	100	8	72	550x1020x720	90	
100BD3T33T	DC00000016	7	720	500	3+3	2,2+2,2	400/50/3	100	8	73	550x1020x720	100	
DENTALIFE DRY													
30BD1M1E	DC00000023	1	120	78	1	0,75	230/50/1	30	8	69	400x640x720	44	
30BD2M2E	DC00000024	2	240	152	2	1,5	230/50/1	30	8	69	400x640x720	53	
50BD2M2E	DC00000025	3	240	152	2	1,5	230/50/1	50	8	69	520x680x900	59	
50BD3M3E	DC00000026	4	360	225	3	2,2	230/50/1	50	8	69	520x680x900	62	
50BD3T3E	DC00000027	4	360	225	3	2,2	400/50/3	50	8	69	520x680x900	62	
100BD2T22TE	DC00000028	6	480	305	2+2	1,5+1,5	400/50/3	100	8	72	650x1020x790	108	
100BD3T33TE	DC00000029	8	720	450	3+3	2,2+2,2	400/50/3	100	8	73	650x1020x790	118	
DENTALIFE SIL													
30BD1M1S	DC00000017	1	120	85	1	0,75	230/50/1	30	8	55	450x700x700	75	
30BD2M2S	DC00000018	2	240	170	2	1,5	230/50/1	30	8	55	450x700x700	76	
50BD3M3S	DC00000019	4	360	250	3	2,2	230/50/1	50	8	55	580x700x1100	96	
50BD3T3S	DC00000020	4	360	250	3	2,2	400/50/3	50	8	55	580x700x1100	96	
100BD2T22TS	DC00000021	6	480	340	2+2	1,5+1,5	400/50/3	100	8	59	510x1200x800	150	
100BD3T33TS	DC00000022	8	720	500	3+3	2,2+2,2	400/50/3	100	8	63	510x1200x800	170	
DENTALIFE DRY SIL													
30BD1M1ES	DC00000030	1	120	78	1	0,75	230/50/1	30	8	55	450x700x700	80	
30BD2M2ES	DC00000031	2	240	152	2	1,5	230/50/1	30	8	55	450x700x700	89	
50BD3M3ES	DC00000032	4	360	225	3	2,2	230/50/1	50	8	55	580x700x1100	105	
50BD3T3ES	DC00000033	4	360	225	3	2,2	400/50/3	50	8	55	580x700x1100	105	
100BD2T22TES	DC00000034	6	480	305	2+2	1,5+1,5	400/50/3	100	8	63	510x1200x800	190	
100BD3T3TES	DC00000035	8	720	450	3+3	2,2+2,2	400/50/3	100	8	63	510x1200x800	190	